

AMENDMENT NO. 1 DECEMBER 2020

TO

**IS 1293 : 2019 PLUGS AND SOCKET-OUTLETS
FOR HOUSEHOLD AND SIMILAR PURPOSES
OF RATED VOLTAGE UP TO AND INCLUDING
250 V AND RATED CURRENT UP TO AND
INCLUDING 16A — SPECIFICATION**

(Fourth Revision)

(Page 1, clause 1, NOTES 6) — Insert the following new note at the end:

‘7 The particular requirements for adaptors are covered under separate standard.’

<http://www.china-gauges.com/>

(Page 3, Fig. 1) — Substitute the following for the existing:

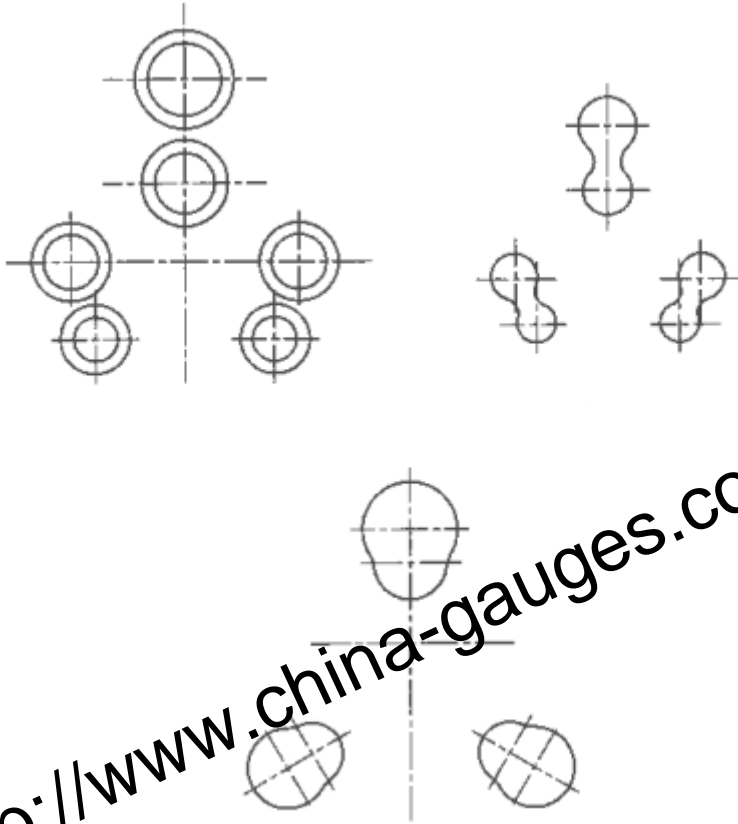
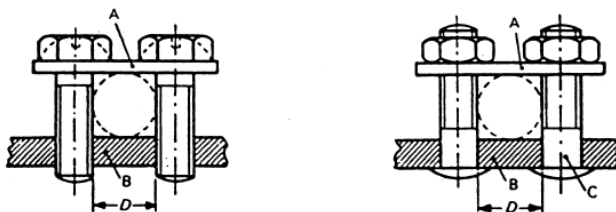

FIG. 1C COMBINED SOCKET-OUTLETS'

(Page 5, Fig. 2, informal table, col 3 and col 4, title) — Insert ‘,Nm’ after Torque¹⁾.

(Page 6, Fig. 3, para 1, line 1) — Substitute ‘the’ for ‘tire’.

(Page 7, Fig. 4) — Substitute the following for the existing:



Key

A = Saddle

B = Fixed part

C = Stud

D = Conductor Space

<i>Cross-section of Conductor Accepted by the Terminal (mm²)</i>	<i>Minimum Diameter D of Conductor Space (mm)</i>	<i>Torque Nm</i>
Up to 4	3.0	0.5
Up to 6	4.0	0.8
Up to 10	5.0	1.2

The shape of the conductor space may differ from that shown in the figure, provided that a circle with a diameter equal to the minimum value specified for D can be inscribed.

The shape of the upper and lower faces of the saddle may be different to accommodate conductors of either small or large cross sectional areas by inverting the saddle.

FIG. 4 SADDLE TERMINALS

(Page 8, Fig. 5) — Substitute the following for the existing:

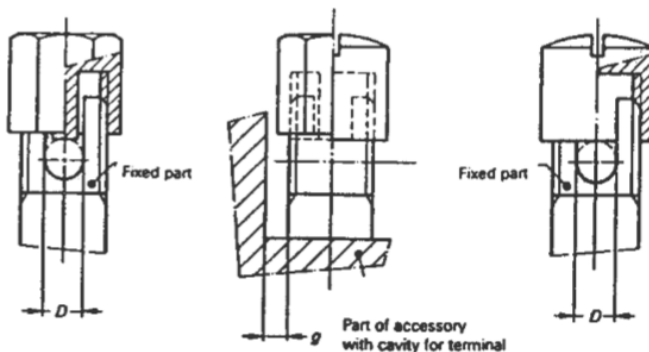

<i>Cross-Section of Conductor Accepted by the Terminal</i> (mm ²)	<i>Minimum Diameter D of Conductor Space</i> ¹⁾ (mm)	<i>Minimum Distance g Between Fixed Part and End of Conductor When Fully Inserted</i> (mm)
Up to 1.5	1.7	1.5
Up to 2.5	2.0	
Up to 4	2.7	1.8
Up to 6	3.6	1.8
Up to 10	4.3	2.0

¹⁾ The bottom of the conductor space must be slightly rounded in order to obtain a reliable connection.



NOTE — The value of the torque to be applied is that specified in col 4 or col 5 of Table 1 as appropriate.

FIG. 5 MANTLE TERMINALS

(Page 9, Table 2) — Substitute the following for the existing table:

‘Table 2 Preferred Combination of Types and Ratings

(Clause 6.1)

SI No.	Type	Rated Current A
(1)	(2)	(3)
i)	2P (non-rewireable plugs only)	2.5
ii)	2P (non-rewireable plugs only), 2P + 	6
iii)	2P (non-rewireable plugs only), 2P + 	16
iv)	2P +  (combined socket-outlets only)	6/16

(Page 12, clause 9.2, para 2, line 2) — Delete the words ‘or of’.

(Page 12, Table 3, SI No. 4, col 2) — Substitute ‘pin’ for ‘pint’

(Page 13, Fig. 8) — Substitute ‘5 mm (min)’ for ‘MIN’.

(Page 14, Table 4, footnote 1) — Substitute the following for the existing:

‘¹⁾The use of flexible conductors is permitted.’

(Page 14, Table 4, footnote 2) — Substitute the following for the existing:

‘²⁾The terminal shall allow the connection of two 1.5 mm² conductors which have a diameter of 1.45 mm.’

(Page 21, Table 7, Sl No. i), col 2, row 1) — Substitute ‘Above 0.75 up to 1.5 inclusive’ for ‘Above 0.75 up to inclusive’.

(Page 22, clause 12.2.8, para 3, line 2) — Substitute ‘Table 4’ for ‘Table 3’.

(Page 31, clause 13.9, para 3, line 3) — Substitute ‘Table 15’ for ‘Table 14’.

(Page 32, clause 13.14, para 2, line 3) — Substitute ‘Fig. 14’ for ‘Fig. 13’.

(Page 38, Table 16, col 3 to col 6, title) — Substitute ‘**Rewireable**’ for ‘**Rewritable**’.

(Page 38, Table 16, col 3 to col 6, title) — Substitute ‘**Non-rewireable**’ for ‘**Non-rewritable**’.

[Page 38, Table 16, Sl No. ii)] — Substitute the following for the existing

ii)	6A 250 V	9	6	8.4	6	—	—	—	Tinsel	1
									2.5	2.5
									0.75	9
									1	9
										6
										6

(Page 38, clause 14.23, para 3, line 2) — Substitute ‘6 A’ for ‘10A’.

(Page 40, Table 15, row 3) — Substitute the following for the existing:

iii)	above 6A upto and including 16A, upto and including 250 V	2	IS 694	2 × 0.75	2.7 × 5.4	3.2 × 6
				2 × 1.5	7.4	9.0
		3	IS 694	3 × 0.75	6.4	9.8
				3 × 1.5		

(Page 44, clause 19.1, para 8, line 1) — Substitute ‘Fig. 18’ for ‘Fig. 39’.

(Page 44, clause 19.1, para 13, line 3) — Insert ‘60⁺⁵₀ min’ at the end of the sentence.

(Page 46, clause 19.2, para 3, line 2) — Insert ‘60⁺⁵₀’ before ‘min’.

(Page 47, clause 20, para 4, line 2) — Insert ‘if applicable,’ before ‘with insulating sleeves,’.

(Page 48, Fig. 19, DETAIL ‘A’) — Substitute ‘r =10’ for ‘r = 1D’

(Page 48, Fig. 19) — Insert the following before the caption of Fig 19:

‘The spring other than spring B, are so chosen and adjusted that:

In the disengaged position they exert a force on the plug carrier or specified in the following table.

When compressed by one-third of the difference between the length in the disengaged position and the fully compressed length, they exert a force equal to 1.2 times the appropriate maximum withdrawal force specified in 22.

Rating	Number of Poles	Force on the Plug Carrier
Up to and including 6 A	2	3.5
Above 6A up to and including 16 A	2	7.2

(Page 50, clause 21.1, para 6, line 2) — Insert ‘if applicable,’ before ‘with insulating sleeves,’.

(Page 51, Table 19, A, 2) — Substitute the following for the existing:

ii)	above 6A upto and including 16A	2	50	2.0
		3	54	

(Page 52, clause 22.2, para 4) — Substitute the following for the existing:

‘The diameter, for round pins, and the distance between contact surfaces shall have respectively the minimum specified dimensions, with a tolerance of mm and a length sufficient to make adequate contact with the contact assembly. The force of the gauge shall be equal to that specified in Table 19.’

(Page 55, Table 21, Sl No. i), col 2) — Substitute ‘6A Up to and including 250V ²⁾’ for ‘2.5A/6A Up to and including 250V ²⁾’.

(Page 55, Table 21, Sl No. ii), col 2) — Substitute ‘6A Up to and including 250V’ for ‘2.5A/6A Up to and including 250V’.

(Page 55, clause 23.4, para 15) — Delete.

(Page 61, Table 23, Sl No. ii), col 2) — Substitute ‘Above 14, up to and including 20’ for ‘Above 14, up to and’.

(Page 61, Table 23, Sl No. iii), col 2) — Substitute ‘Above 20’ for ‘including 20 Above 20’.

(Page 69, Fig. 33, Title) — Substitute ‘FIG. 32’ for ‘FIG. 29’.

(Page 73, clause 28.1.1, para 6) — Substitute the following for the existing:

‘Small parts, where each surface lies completely within a circle of 15 mm diameter, or where any part of the surface lies outside a 15 mm diameter circle and where it is not possible to fit a circle of 8 mm diameter on any of the surfaces, are not subjected to the test of this sub clause. Diagrammatic representation is as shown below:

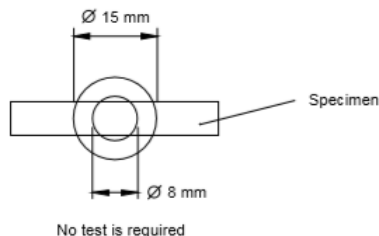
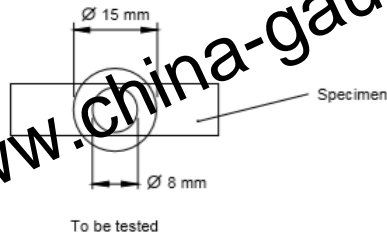

NOTE — When checking a surface, projections on the surfaces and holes which are not greater than 2 mm on the largest dimension are disregarded.’

(Page 79, Annex B, col 2 and 3, row 9) — substitute ' 7.5_0^{+1} ' for ' 7.5 '.

(Page 79, Annex B, col 4, row 9) — substitute ' 9_0^{+1} ' for ' 9 '.

(Page 88, Annex F, Table 24, cols 6 and 7) — Substitute the following for the existing:

C_1	C_2
(6)	(7)
0	3
0	5
1	5
1	6
2	7
3	10
5	12

(Page 88, Annex F, clause F-2.1, line 2) — Substitute ' $less$ ' for ' $greater$ '.

<http://www.china-gauges.com/>